

PVM Plus Series

On/Off Grid Energy Inverter

Pure sine wave solar inverter

Output power factor 1.0

Parallel operation up to 9 units

High PV input voltage range

Battery independent design

Built-in 80A/100A MPPT solar charger

Battery equalization function to optimize battery performance and extend lifecycle

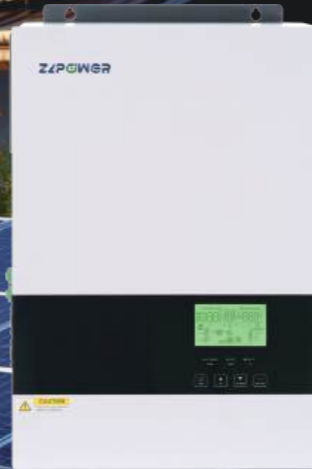

Hybrid Operation

★ With battery connected

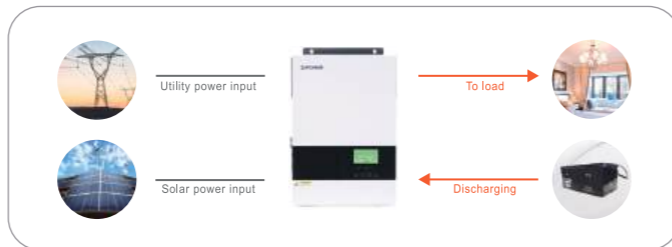
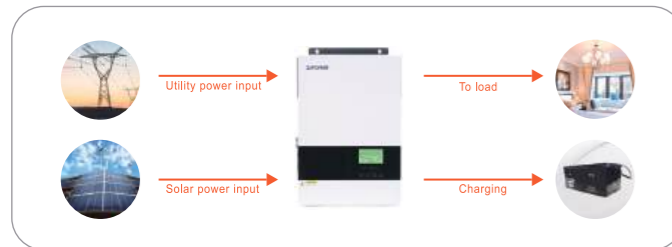

★ Without battery connected

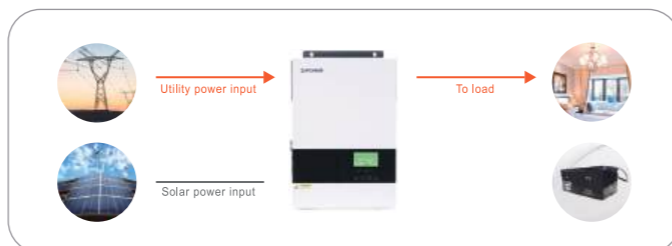
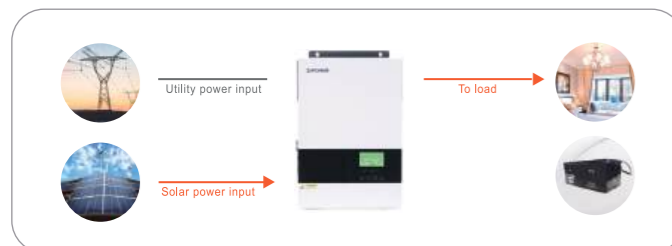

Single phase output up to 49.5KW using 9units

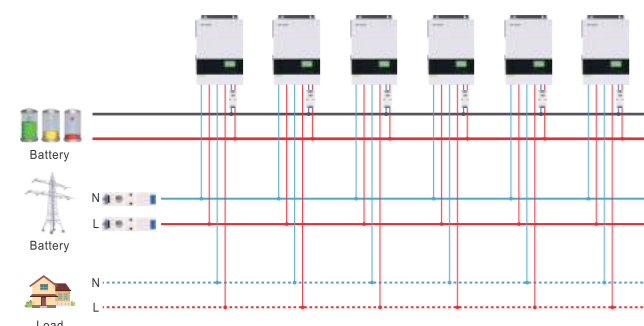

Three phase output using either 3units(16.5KW) or max 9 units(49.5KW)

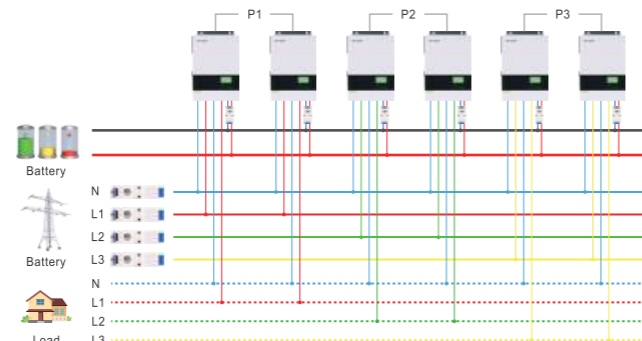

PVM Plus ON/Off-Grid Inverter Selection Guide

MODEL	PVM Plus 3000-24	PVM Plus 3500-48	PVM Plus 5500-48
Rated Power	3000VA/3000W	3500VA/3500W	5500VA/5500W
Battery Type	Lithium/Lead-acid		
INPUT			
Voltage	230 VAC		
Selectable Voltage Range	170-280VAC(For Personal Computers) ; 120-280VAC(For Home Appliances)		
Frequency Range	50Hz/60Hz(Auto sensing)		
OUTPUT			
AC Voltage Regulation(Batt.Mode)	230VAC±5%		
Surge Power	6000VA	7000VA	11000VA
Efficiency	UP to 93.5%		
Transfer time	10ms(For Personal Computers) ; 20ms(For HomeAppliances)		
Waveform	Pure sine Wave		
BATTERY			
Battery Voltage	24.0VDC	48.0VDC	48.0VDC
Floating Charging Voltage	27.4VDC	54.8VDC	54.8VDC
Overvoltage protection	33.0VDC	63.0VDC	63.0VDC
SOLAR CHARGER & AC CHARGER			
Max. PV Array Open Circuit Voltage		500VDC	
Max.PV Array Power	4000W	4000W	5500W
MPPT Operating Voltage Range	120-450VDC	120-450VDC	120-450VDC
Max Solar Charging Current	100A	60A	100A
Max AC Charging Current	60A	40A	80A
Max Charging Current	100A	60A	100A
PHYSICCAL			
Dimension L*W*H(mm)	486x313x125		
Net weight(kg)	9.6	9.6	11.6
Communications interface	RS232/RS485/CAN/USB/Dry contact		
ENVIRONMENT			
Humidity	5% to 95% Relatiye Humidity (Non-condensing)		
Operating Temperature	-10°C to 50°C		
Storage temperature	-15°C to 60C		

Product specifications are subject to change without further notice.

